

EWELLIX

MAKERS IN MOTION

# Linear technology for joining

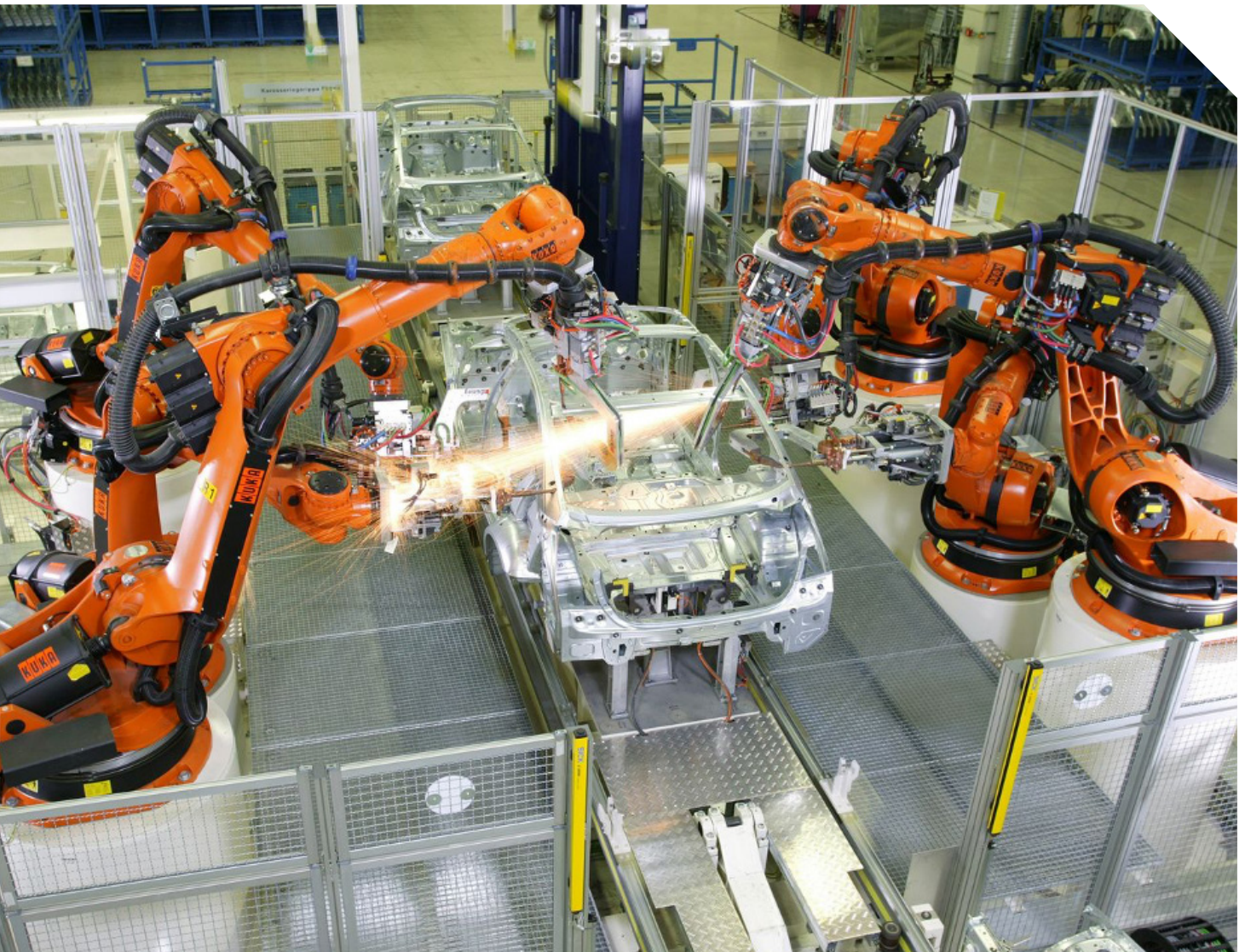

# The heritage of innovation

Ewellix is a global innovator and manufacturer of linear motion and actuation solutions used in assembly automation, medical applications and mobile machinery. Formerly part of SKF Group, the Ewellix Group consists of 16 sales units and six factories. External net sales are approximately 250 EUR million and we employ around 1 250 people. Ewellix is headquartered in Gothenburg, Sweden and is owned by Triton.

## Technology leadership

Our journey began **over 50 years** ago as part of the SKF Group, a leading global technology provider, with the world's first precision ball and roller screw factories. Our history with SKF provided us with the **expertise to continuously develop new technologies** and use them to create cutting edge products that offer our customers a competitive advantage.

In 2019, we became independent from SKF and changed our name to Ewellix. **We are proud of our heritage.** This gives us a unique foundation on which to build an agile business with engineering excellence and innovation as our core strengths.

## Global presence and local support

With our **global presence**, we are uniquely positioned to deliver **standard components and custom-engineered solutions**, with full technical and applications support around the world. The long lasting relationships with our distributor partners allow us to support customers in a variety of different industries. At Ewellix, we don't just provide products; **we engineer integrated solutions** that help customers realise their ambitions.



1250 employees



6 factories



16 sales units



2 competence centres

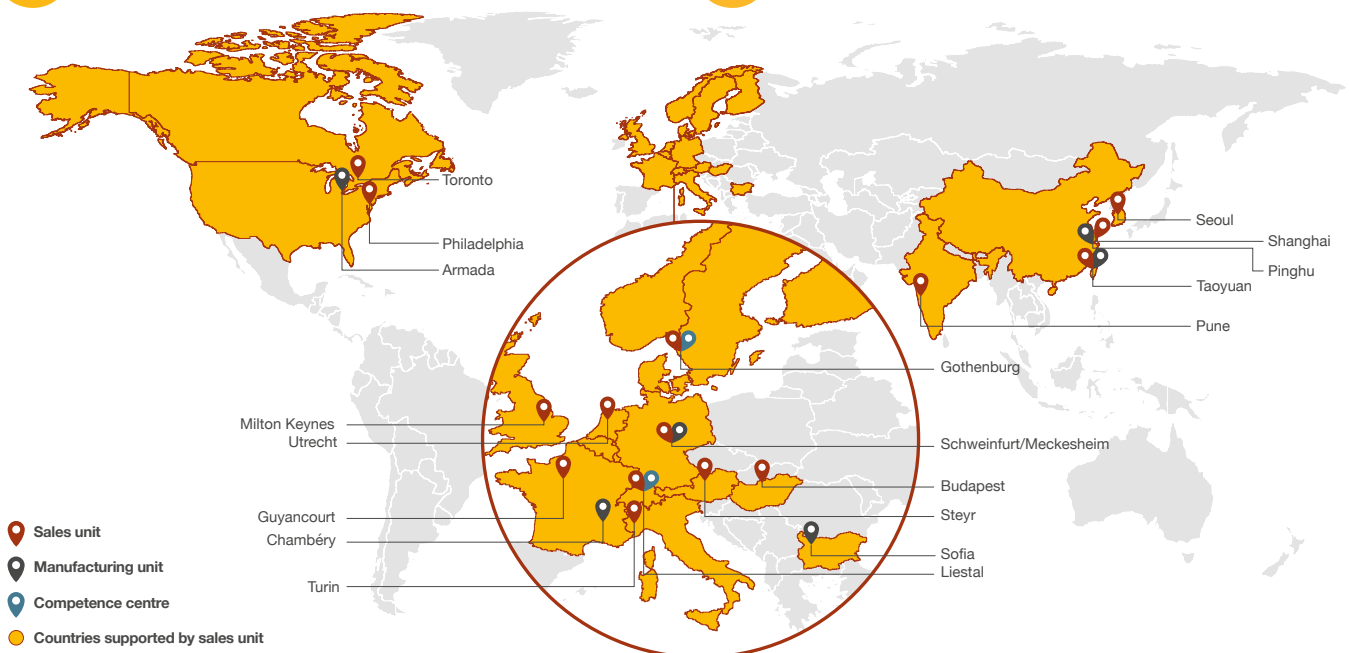



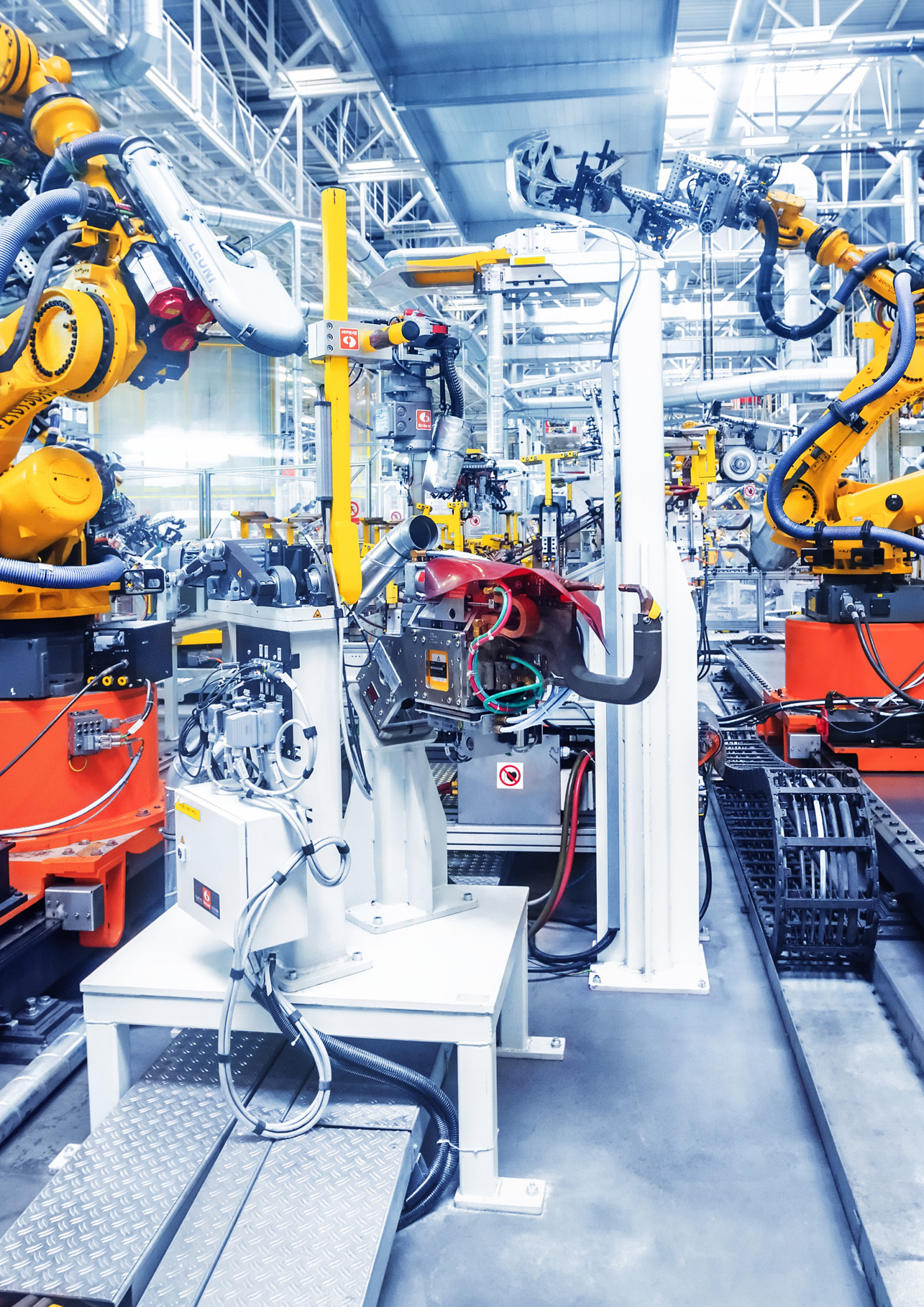



# Electrification in the automotive industry

All industries are adopting solutions that reduce environmental impact and leverage new technology. Ewellix provides technical expertise to overcome customers' challenges, providing components for the development of more efficient automotive manufacturing equipment.

Electrification is a macro-trend across the automotive industry, from car production to the vehicle itself. The technology shift from internal combustion engine to electric powertrain has accelerated over the last decade, supported by stringent regulations on CO<sub>2</sub> emissions and by government's incentives.

Automakers are strategically pursuing vehicle weight reduction to meet regulatory and market goals, and this is mainly achieved through a combination of design optimization, downsizing, and lower weight materials. As a result, new generations of automobiles are expected to contain an increasingly larger quantity and diversity of innovative materials.

This significant change requires new flexible production lines and it necessitates the evolution of joining technologies such as dispensing, welding, riveting, clinching.

With decades of automation experience, Ewellix has a unique understanding of linear motion and how it is integrated into customers' applications to provide the best performance and greater machine efficiency: We assist our customers by creating equipment that runs faster, longer and safer and that is sustainable.

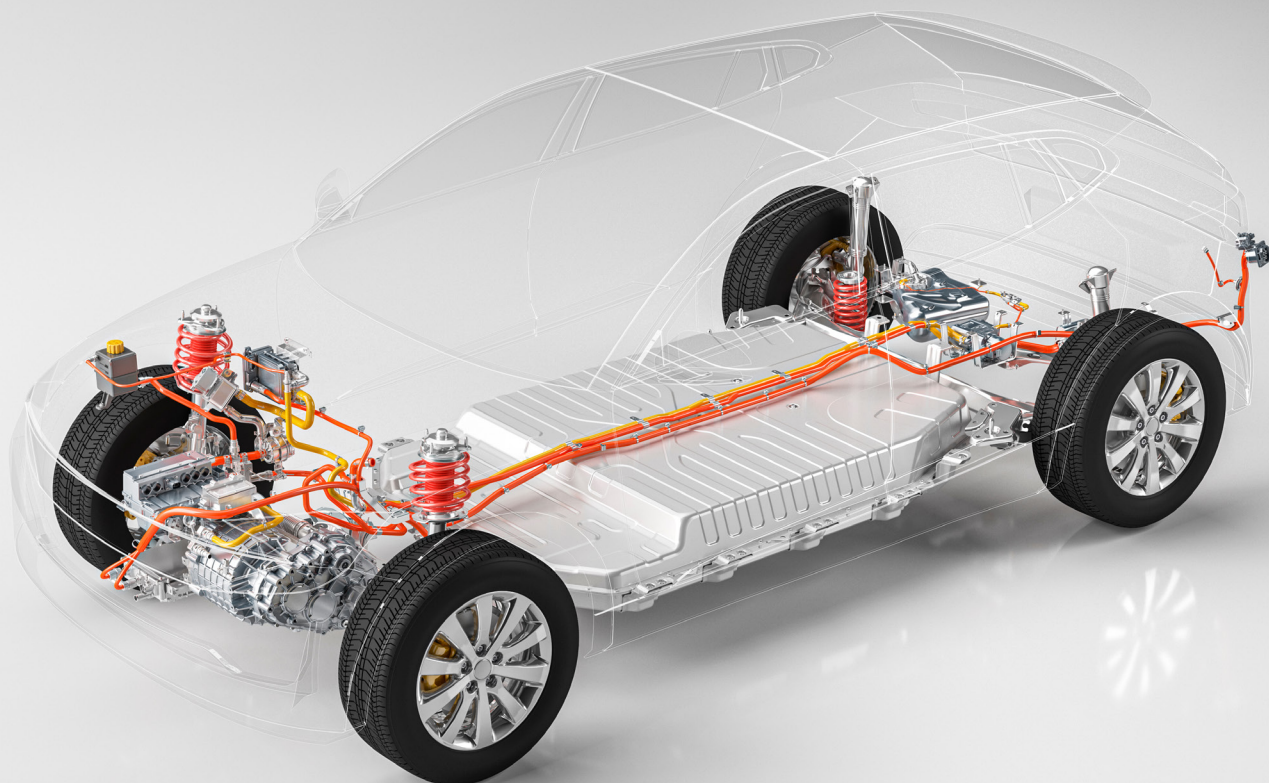



## The evolution of joining technologies

Incorporating different materials into a vehicle is one of the greatest challenges that the automotive industry faces. Dissimilar materials require various joining technologies such as resistance spot welding, self-piercing riveting, and a variety of fast-cure adhesive bonding processes incorporated into flexible assembly lines that meet vehicle production rates. OEM's must consider several factors when selecting joining technologies in the body shop. For example:

- Accessibility
- Technology maturity
- Number of joints per minute and cycle time
- Joint performance and strength
- Cost-effective joining techniques
- Multi-material compatibility
- Automated or manual process
- Removing design limitations

Electrical systems in automation lines help improve assembly processes and follow market trends, thanks to flexibility and programmability.

The average automotive production line consists of hundreds of robots for welding, gluing and riveting. Electro-mechanical actuation is more reliable and more energy-efficient than pneumatic actuation. Ewellix's mechatronic solutions integrated in automotive assembly lines reduce downtime, maintenance operations and total cost of ownership.





# Quest for reliability and sustainability in automotive assembly







A relevant example of the need for reliability is EV battery assembly, where quality control is essential. Once the enclosure is sealed, failures are difficult and costly to correct. Consequently, assembly processes require precision and repeatability. Following the rapid growth in battery production, new assembly solutions are emerging with key challenges. Bonding with accurately dispensing and applying adhesives, self-piercing riveting with high quality and repeatability.

Automotive manufacturers strive to cut production costs through increased process speed, shortened cycle time, while increasing quality and performance. Assembly cells with electrical actuation and Ewellix compact linear motion products can be downsized to a smaller footprint.

## Critical drivers for electrification and new flexible assembly lines

-  Better productivity
-  Lower cost with energy savings
-  Flexibility and programmability
-  Environmentally friendly

*Electrification is the smart solution for:*

	Features	Electric systems value proposition
	Environmental pollution risk	None
	Energy consumption while not in use	Close to zero
	Safety in operation	Very easy
	Positioning precision	High
	Controlled speed	Easy
	Maintenance	Seldom
	Cost of maintenance	Very low
	Remote monitoring	Easy



# Enhanced productivity, increased flexibility

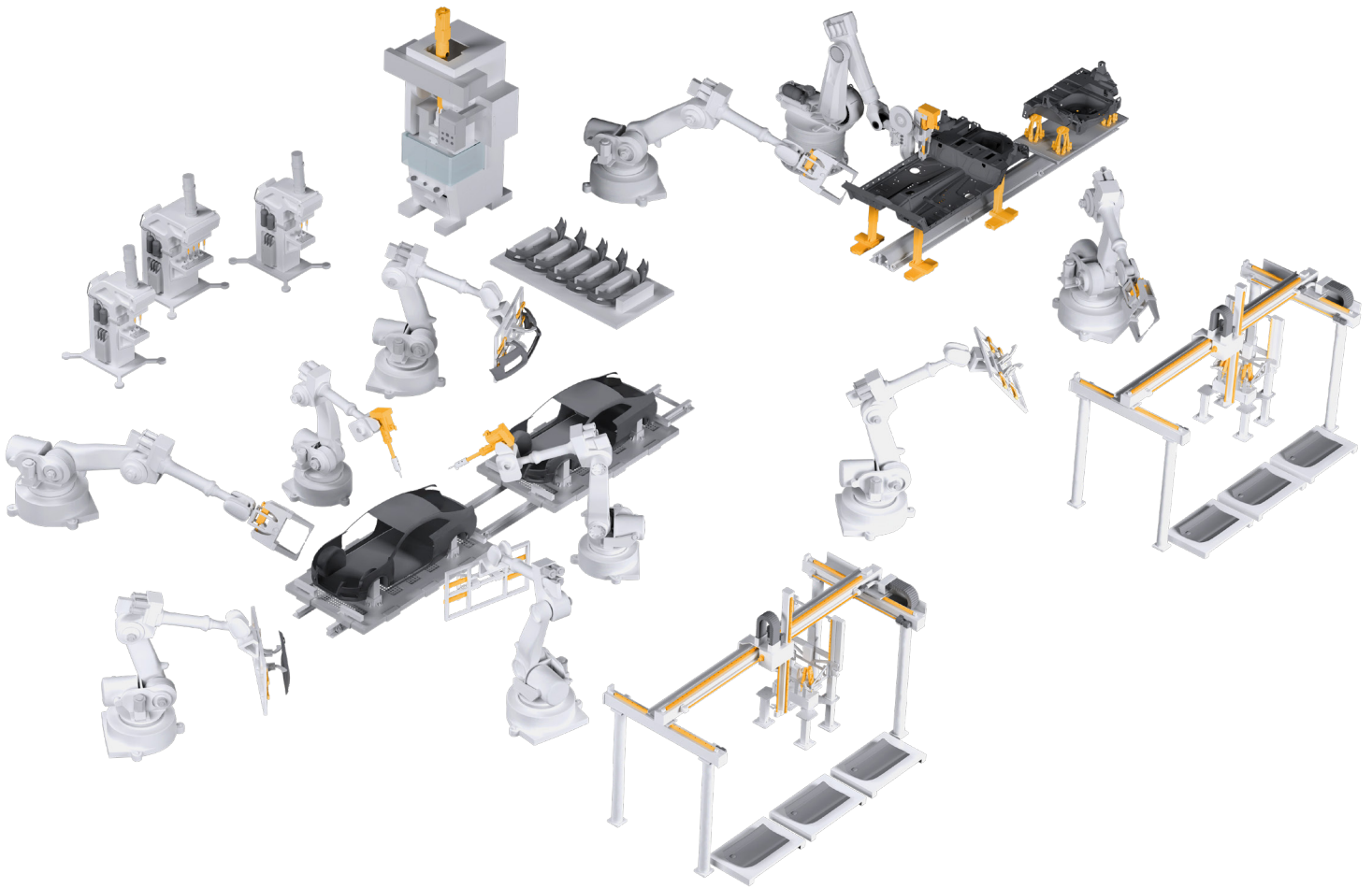



# Resistance spot welding

Electric systems are ideal for making many welded joints quickly, precisely, cleanly, economically and with consistent quality. Whatever the weld gun design (direct-acting known as “C” gun, “L” or “X” also known as scissor, or pinch gun), the requirements are very similar.

Electrical actuators are fast to install and maintain their settings throughout the entire production process. Welding equipment runs continuously under the same optimum conditions.

Ewellix planetary roller screws and dedicated actuators respond to the welding market needs and challenges and offer the best-in-class performance in the field.

### Application requirements

- Very compact, fully integrated design
- Reduced number of components to minimize weight
- High efficiency and robustness
- High-speed and acceleration capabilities
- Low maintenance requirements

### Ewellix’s value proposition

- Modularity for easy integration in equipment
- Lightweight reducing welding robot power and size
- High number of welding spots with roller screw technology
- Minimized downtime thanks to roller screw reliability

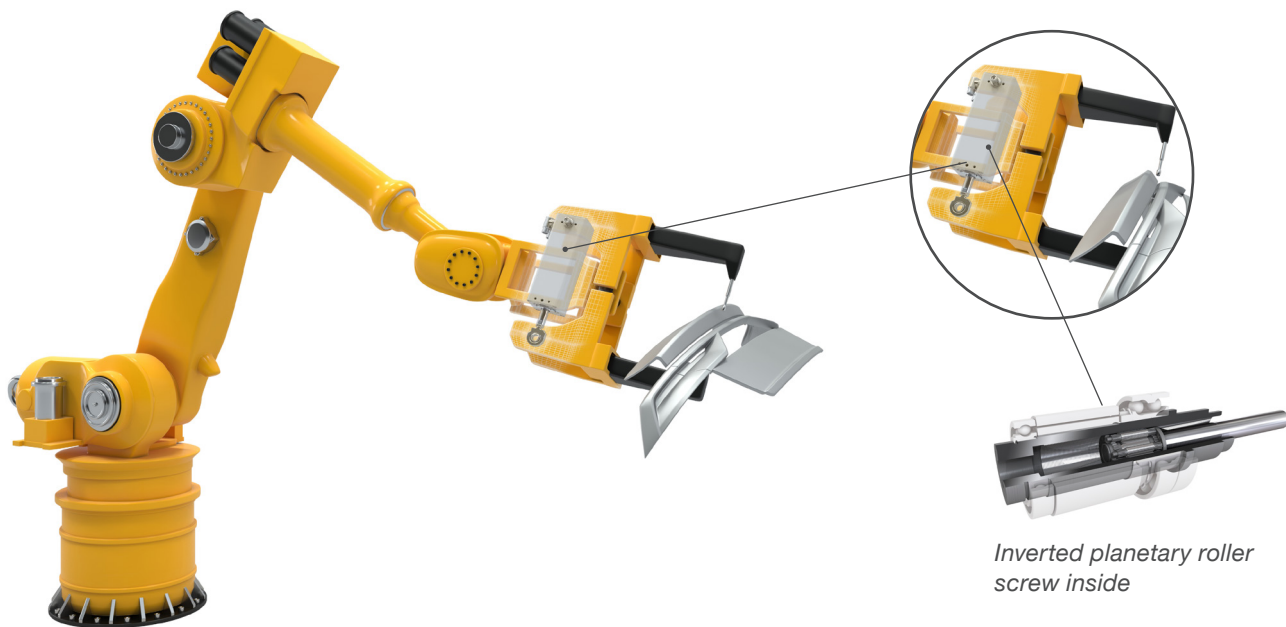

Roller screws

High performance actuator



Planetary roller screws

Inverted planetary roller screw

CEMC



# Mechanical fastening

In the coming years, mechanical joining technologies such as riveting are expected to experience significant developments driven by the electrification of the automotive industry. For instance, self-piercing riveting is very adaptable to join mixed lightweight materials such as high-grade steel or aluminum alloys.

The industry is demanding robust, reliable and cost-effective joints accomplished with repeatable, fast and easy to apply processes.

Ewellix linear actuators with roller screw drive provide customers with high power density actuation for heavy duty applications, while performing quality joints.

## Mechanical fastening technologies

- Self Piercing Riveting
- Blind rivet
- Flow drill

## Application requirements

- Very compact, fully integrated design
- High efficiency and robustness
- High-speed and acceleration capabilities

## Ewellix's value proposition

- Modularity for easy integration in the equipment
- Long service life with roller screw technology
- High force capability with roller screw technology
- Minimized downtime thanks to roller screw reliability

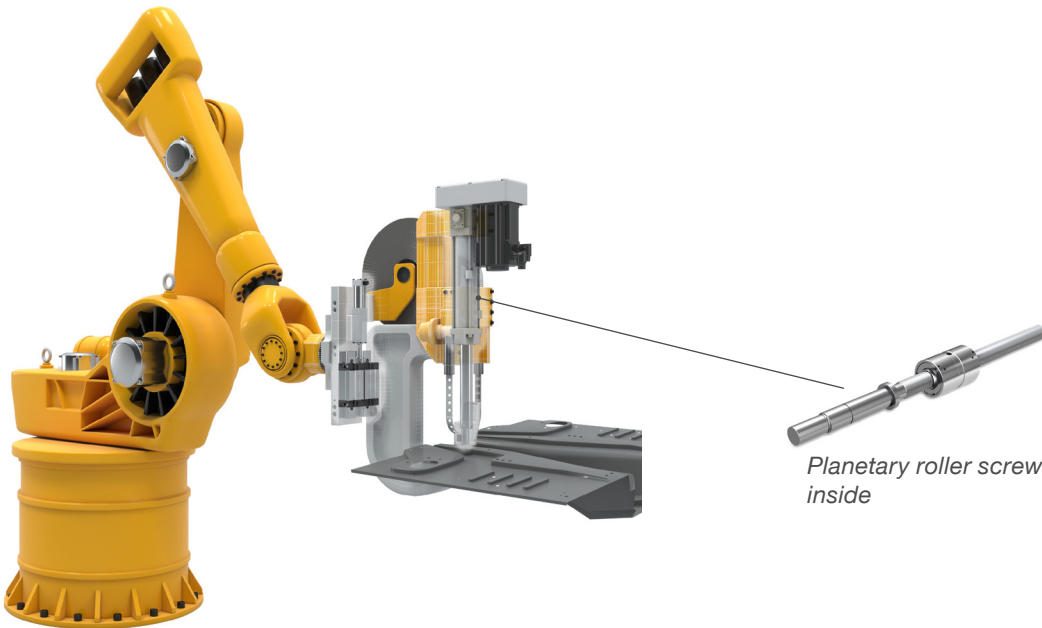

Precision ball screws

Roller screws

High performance actuator



Miniature ball screws



Planetary roller screws

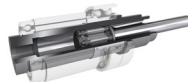

Inverted planetary roller screw



LEMC

# Dispensing

The automotive industry is increasingly relying on adhesive bonds and sealing to make vehicles lighter, safer and more economical. The application of these highly engineered adhesives and seals requires the most precise, robust and dynamic metering systems.

Shear sensitive and abrasive material make the use of linear servo shot meters mandatory. Stitch bead application for structural bonding requires a highly dynamic drive at the end of the robotic arm. Two-components metering needs perfect synchronization of two meters with the same or with different flow rates.

Ewellix roller screws and high-performance actuators offer the best-in-class compactness and lifetime for dispensing system manufacturers for all these applications, proven in the field for many years.

## Application requirements

- Controllability with precise speed and acceleration control
- Repeatability
- High efficiency and robustness
- Cleanliness

## Ewellix's value proposition

- Modularity for easy integration in the equipment
- Long service life with roller screw technology
- Minimized downtime thanks to roller screw reliability

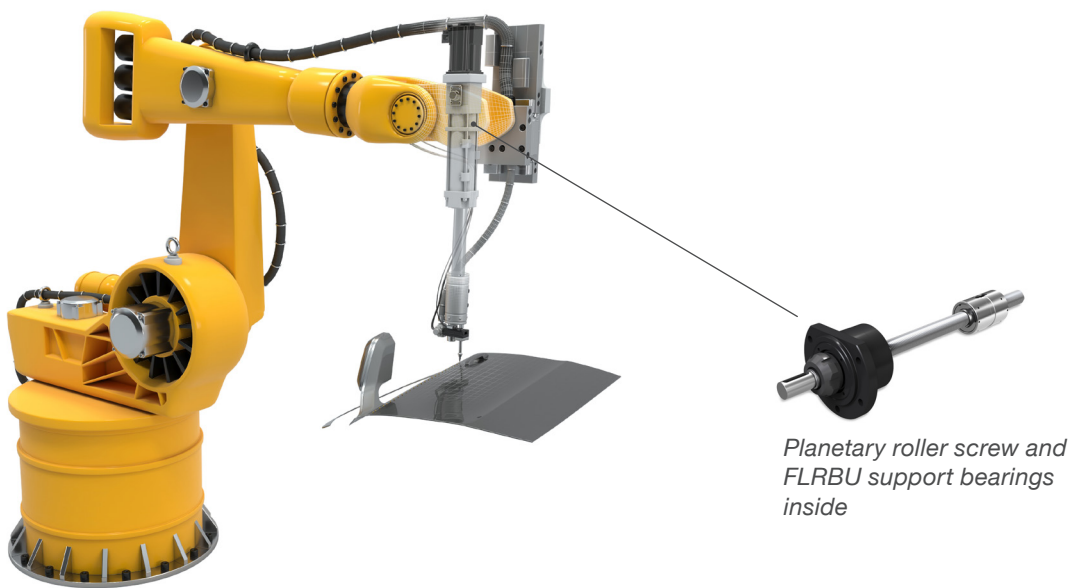

### Roller screws

### High performance actuator

### Support bearings



**Planetary roller screws**



**LEMC**



**CEMC**



**SRSA**



**FLRBU**



# Press forming

Press forming solutions including clinching and hemming are established technologies accomplished by forming metal sheets together.

Clinching technology is a highly reliable process for joining thin metal sheets without additional components, using special tools to form an interlock between multiple sheets through plastic deformation. The key advantage is that a wide range of materials can be joined together without damaging the metal surface.

Hemming is a process of joining metal sheets through rolling or press forming and is mainly used for car closures with decades of successful application.

For press applications, Ewellix offers a wide assortment of planetary roller screws and heavy-duty actuators incorporating such screws. Planetary roller screws are available with various combinations of size and lead to best match customer's requirements in terms of force capacity, robustness and speed.

## Application requirements

- Reduced joining time
- Cleanliness
- Repeatability
- Flexibility
- High efficiency and robustness

## Ewellix's value proposition

- Long service life with roller screw technology
- Ability to withstand peak load over short stroke with roller screw technology
- Minimized downtime thanks to roller screw reliability



Planetary roller screw inside

### Roller screws

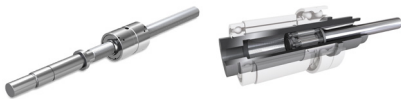

Planetary roller screws

Inverted planetary roller screw

### High performance actuator



CEMC



SRSA

### Support bearings



FLRBU

# Ewellix's core technology for assembly automation: Planetary roller screw

The planetary roller screw technology presents numerous advantages for joining applications that require high load rating, very long service life and extreme reliability.

With planetary roller screws, the application load is transmitted from the nut to the shaft through the barrel-shaped surfaces of the rollers. The number of contacts and the total surface area of the connections between the shaft, the rollers and the nut is substantially increased compared to the ball screw design, resulting in larger dynamic and static load carrying capacities (→ fig. 1).

The absence of recirculating element embodies the fundamental conceptual advantage of the planetary roller screws. Toothed rings and guides ensure the even circumferential position of the rollers without friction. The satellite rollers remain equally spaced and orbit continuously within the planetary mechanism. This is a significant advantage of this product over most ball screw designs.

Fig. 1

Comparison of ball screws and roller screws contact area

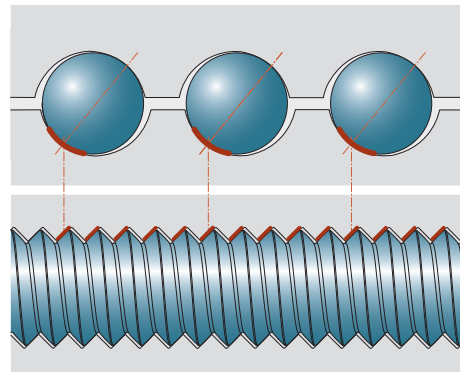
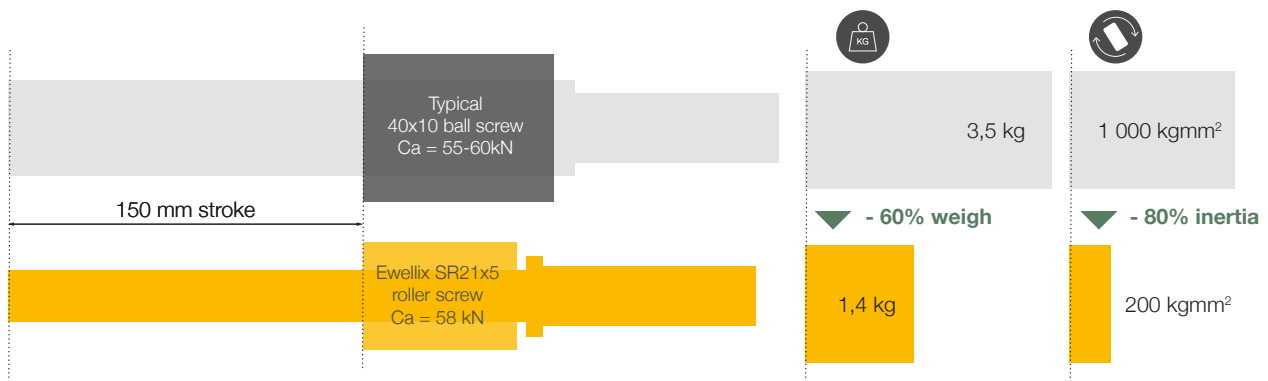
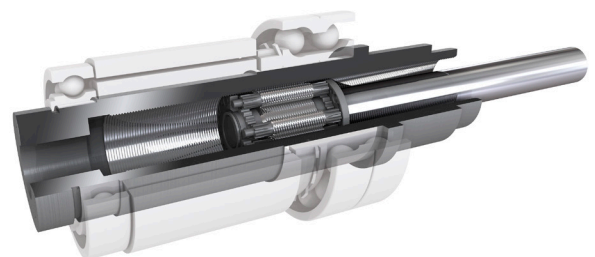

Fig. 2

Mass and inertia saving on an equivalent dynamic capacity screw technology



The inverted planetary roller screw provides powerful electro-mechanical actuation when compactness, low torque and high load capabilities are prerequisites. The rollers are synchronized with the threaded shaft and translate along the nut. Due to the screw shaft being threaded only where the rollers orbit, the screw shaft can incorporate a smooth surface for bushings and seals.





# Roller screw high performances vs. ball screw technology

Ewellix is a pioneer in the technology of roller screws and offers high quality, high performance and the widest assortment of roller screws available on the market. The planetary technology helps to improve screw performances to follow market needs in power density.

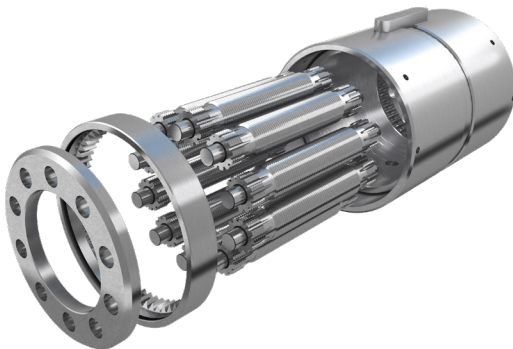
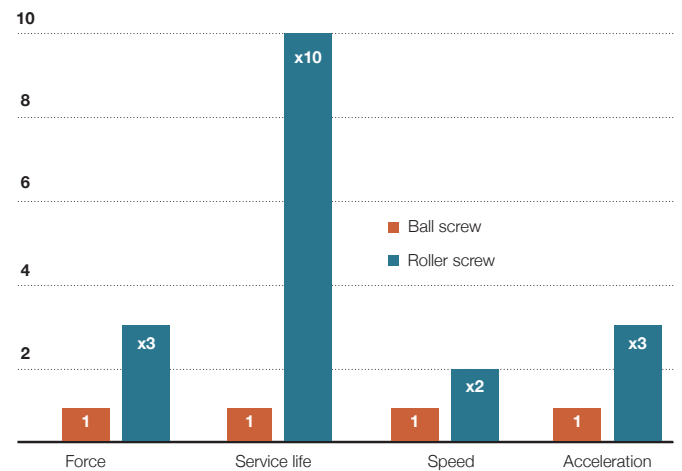

Fig. 3

Comparison of ball screws and roller screws performances



\*On an equivalent screw diameter

## Design features

- Large number of contact points
- Planetary roller screw concept without recirculation with increased thread strength for a given pitch
- Satellite rollers concept with speeds up to 50% higher vs ball screw, and screw acceleration capability up to 3 times higher
- Either nut or shaft can be driven, the non-rotating and translating component acting directly as the push tube
- Customized screw-to-motor attachments for easy integration

## User benefits

- High load carrying capacity and up to 10 times longer service life vs. ball screw
- Long service life and reliability
- Increased speed in operation leading to higher productivity
- Design flexibility, easier to seal the shaft (with turning nut)
- Compact, lightweight solution with fewer parts for easy installation

# High performances actuators offering superior power density

Ewellix offers a complete assortment of actuators with the planetary roller screw as the core technology, to provide the best performance and productivity in the field.

Ewellix's extensive experience and knowledge of actuation systems satisfy the most demanding requirements. Providing a wide variety of electromechanical actuators, Ewellix helps customers reduce the machinery footprint, energy use and maintenance, while improving performance and reliability in the field.



Force capability up to 450 kN



Stroke up to 1 500 mm



Linear speed up to 1 100 mm/s



Options of servo motors to meet application requirements

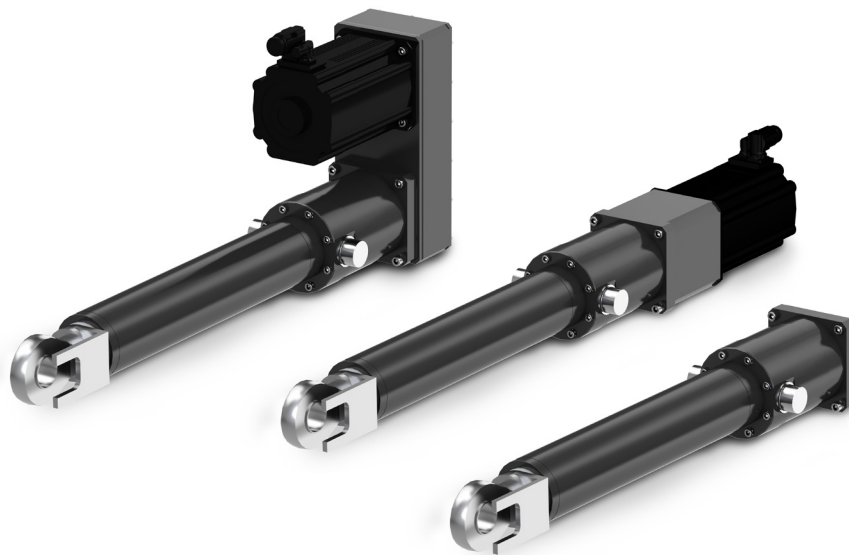

## High-performance actuator features

- High-performance planetary roller screw
- Modular concept
- Robust design
- Options of servo motors and customized motor adapters
- Direct access to roller screw nut for relubrication

## User benefits

- High load capacity and long service life
- High level of design flexibility for easy integration
- High reliability
- High acceleration/deceleration rate and high speed capacity
- Easy and efficient way to relubricate the actuator



# Compact Electro-Mechanical Cylinder for space and weight savings

The latest Compact Electro-Mechanical Cylinders (CEMC) is the perfect example of Ewellix’s know-how to meet market demands. The inverted planetary roller screw technology allows the integration of hollow shaft motors directly onto the roller screw nut, resulting in a very compact yet powerful solution. The CEMC combines multiple tried and tested technologies and is the ideal solution to provide best-in-class performances for resistance spot welding, where high force, robustness and productivity are essential.

-  Compact design within 100 mm square frame, fitting in small spaces while offering high power density and force up to 25 kN.
-  Aluminum housing and reduced number of components resulting in low weight and easy integration in automation equipment.
-  High reliability of inverted roller screw technology for long service life.
-  Construction with individual modules and options for more than 300 possible configurations to match customer application requirements.

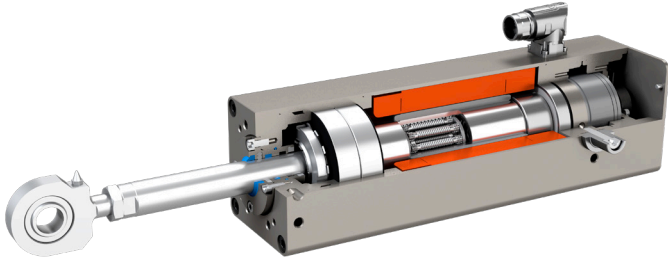

## Performance comparison for welding function\*

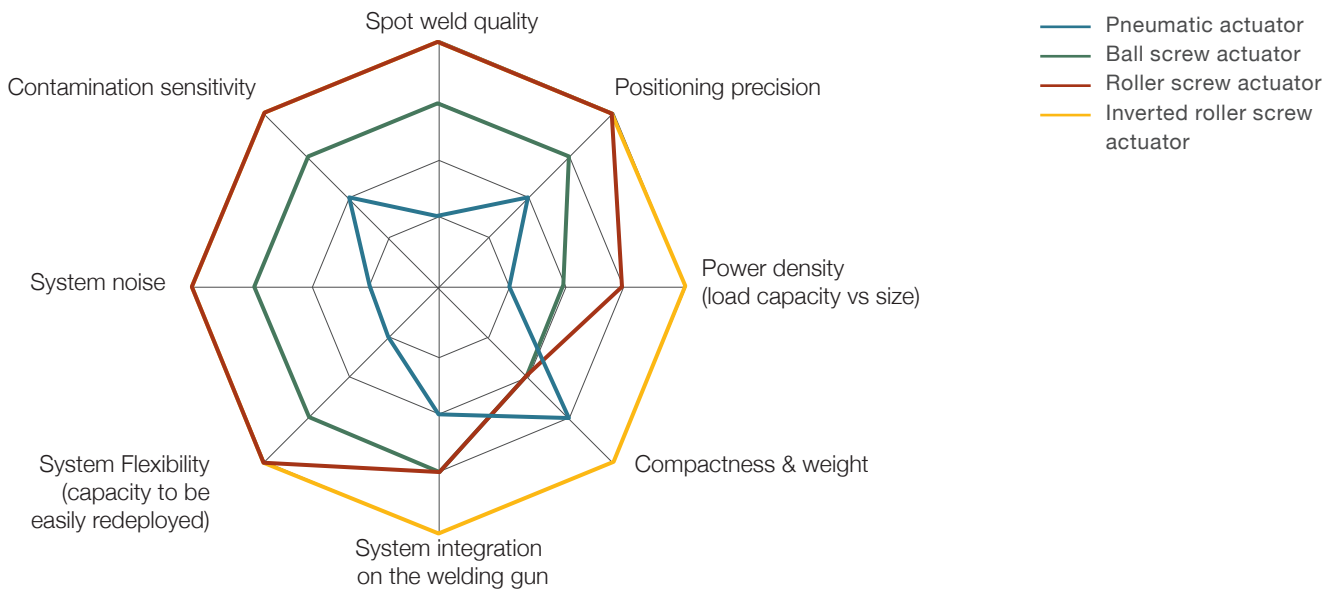

\* Based on Ewellix experience over years in Automotive applications

# Products overview



## Roller screws

	Planetary roller screw	Inverted planetary roller screw*
Dynamic load carrying capacity	up to 4 000 kN	up to 260 kN
Linear speed	up to 1 800 mm/s	up to 500 mm/s
Screw shaft nominal diameter	from 8 to 240 mm	from 18 to 48 mm
Screw lead	from 5 to 50 mm	from 2.4 to 6 mm
Additional features	Cylindrical nut, flanged nut, off-centered flange nut	stroke up to max 200 mm

\* Please contact Ewellix for detailed information



## Support bearings

FLRBU support bearings for roller screws	
Bearing load carrying capacity	Matching roller screws sizes 15 to 80 mm
Angular contact ball bearings arrangement	1+1 (for smaller sizes) 2+2 or 1+3 or 3+1 (for bigger sizes)
Additional features	Bearings assembled with preload Precision locknut (KMT) Greased for life

## High performance actuator



	CEMC	LEMC	SRSA
Max axial force	up to 25 kN	up to 50 kN	up to 450 kN
Dynamic load capacity	59 kN	up to 122 kN	up to 572 kN
Speed	up to 300 mm/s	up to 1 000 mm/s	up to 1 100 mm/s
Stroke	180 mm	up to 800 mm	up to 1 500 mm
Additional features	Integrated servo motor	Linear unit only, or option for attached servo motor	Linear unit only, or option for attached servo motor



# Your engineering partner

Ewellix's extensive product knowledge, combined with engineering expertise, transforms customer needs into tailored solutions. Focusing on client-specific requests, our engineers help customers develop and implement cost-effective solutions for niche markets and for high-volume applications. Our strong understanding of linear and actuation technologies enables us to create new innovative solutions.

Ewellix can offer new actuators based on the roller screw technology, integrating additional mechanical functions, special materials or increased load carrying capacity. Ewellix also has an extensive customization program to meet unique application requirements.

## Actuator and roller screw customization capabilities

- Materials
- Housing
- Guiding system
- Screw (lead, heat-treatment, etc.)
- Screw nut design
- Stroke
- Mounting attachments
- Motor/gearbox attachment

## Complete customization

If the standard assortment cannot fulfill specific technical requirements, Ewellix can offer completely customized solutions tailored for each customer.

Customized solution for resistance spot welding

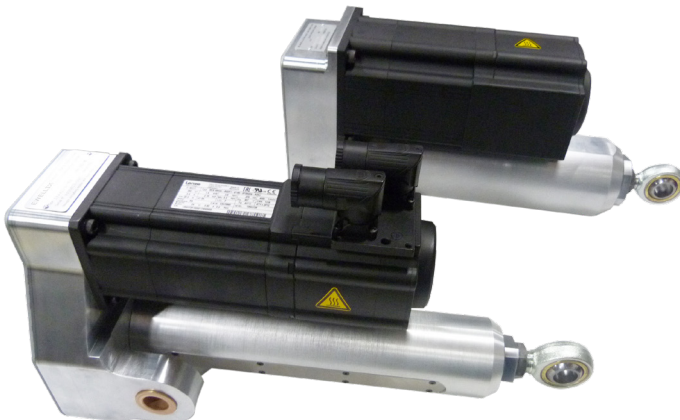

CEMC lab testing



# Supporting tools

## Digital

Ewellix has developed numerous online tools to help customers select and calculate the most suitable Ewellix product for their application.

### Ball and roller screws

- Product selection
- Product calculator
- Product verification

### Actuators

- Product selection
- Performance calculator
- Cost-saving calculator

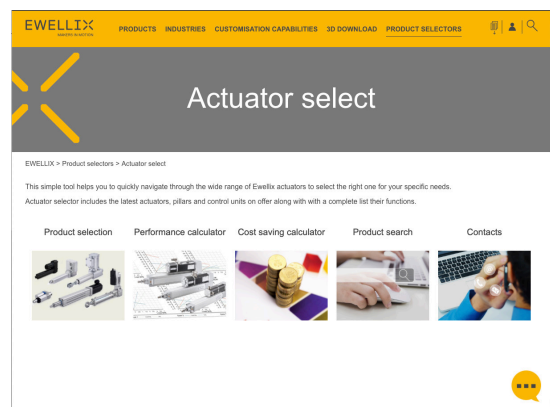
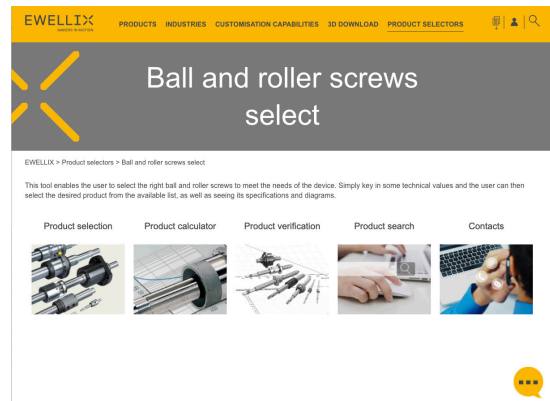

## Publications

Supporting documents are available for downloading on ewellix.com on each product page under the technical data section:

- Operating manual
- Mounting instructions

Roller screw



Electric cylinders LEMC



Electric cylinders CEMC



Electric cylinder SRSA and SVSA







**ewellix.com**

© Ewellix

All contents of this publication are the property of Ewellix, and may not be reproduced or given to third parties (even extracts) without permission. Although great care has been taken in the production of this catalog, Ewellix does not take any responsibility for damage or other loss resulting from omissions or typographical errors. The photo may differ slightly in appearance from the actual product. Due to continuous improvements being made in our products, the product's appearance and specifications are subject to change without notice.

**PUB EL-03008/1-EN-September 2022**

Certain image(s) used under license from Shutterstock.com.  
SKF and SKF logo are trademarks of the SKF Group